

MIXPAC™ Q-System Overview

150/310/380mL Construction Set

ACCESSORIES

ID	Description
 301255	Perforated sleeves
The perforated sleeves support chemical anchoring to brick walls.	
 301268	Plunger 150mL, 10:1
Additional plunger needed for 150 mL cartridge.**	

MIXER

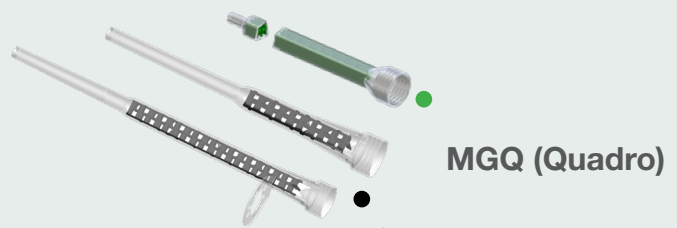

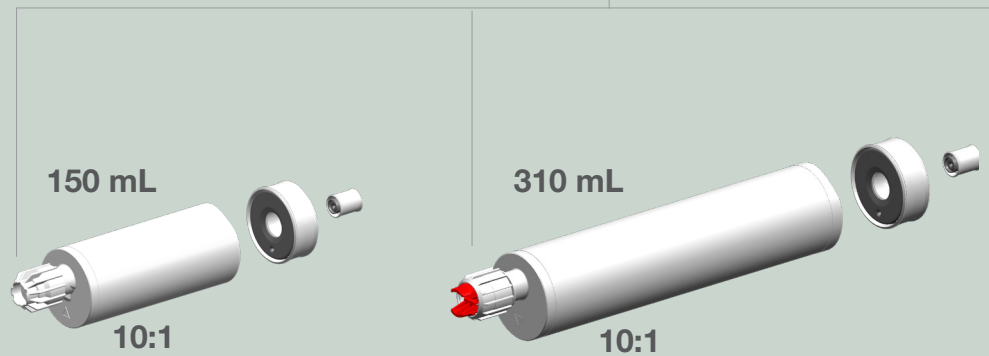

CARTRIDGE



DISPENSER



** Needs additional plunger!

ID	Description
 300326	Ribbon adapter
 301581	Extension tube Ø 8.5 mm, 200 mm
 300812	Extension tube Ø 7.0 mm, 190 mm

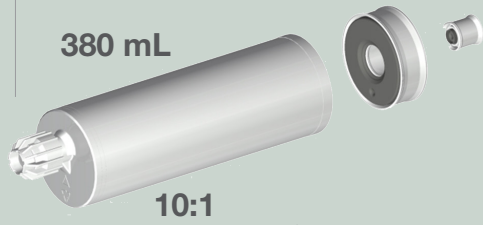
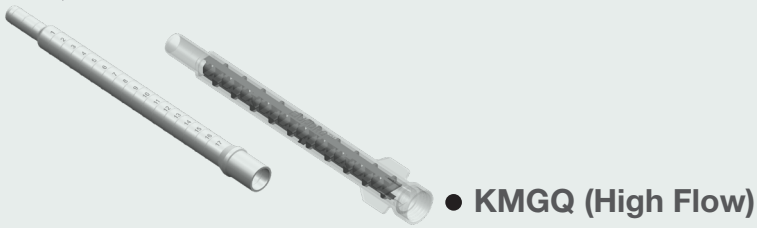

MIXPAC™ Q-System Cartridge Set

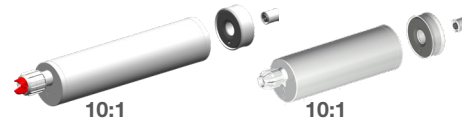

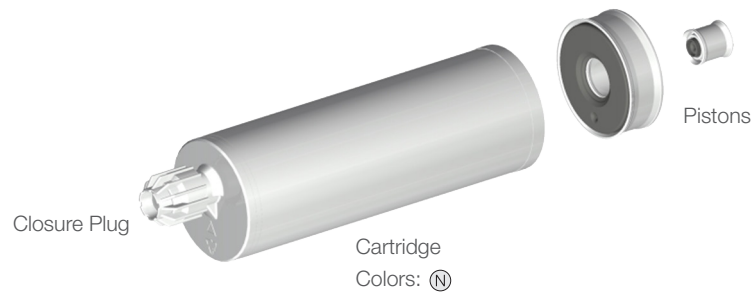

150/310/380mL Construction Set

Cartridge Assembly 150/310/380mL





Ratio Set/ Volume	ID	Article	Cartridges Material/ Color	Pistons Material	Outlet	Units/ Pallet	Mixer Technology	Matching Dispenser
10:1	301284	AQ 150-10-10-01	PP/ (N)	Outer and inner vented PA, cover plate LDPE, piston body	coax	3600	MGQ ●●● KMGQ ●●	DM1 ● DM2 ●
150mL	301283	AQ 150-10-30-01	PA/ (N)	Outer and inner vented PA, cover plate LDPE, piston body	coax	3600	MGQ ●●● KMGQ ●●	DM1 ● DM2 ●
10:1 310mL	301150	AQ 310-10-10-01	PP/ (N)	Outer and inner vented PA, cover plate LDPE, piston body	sbs	2280	MGQ ●●● KMGQ ●●	DM2 ● DB2 ●
10:1 380mL	301844	AQ 380-10-30-01	PA/ (N)	Outer and inner vented PA, cover plate LDPE, piston body	coax	1782	MGQ ●●● KMGQ ●●	DM2 ● DB2 ●

Matching mixers

	ID	Article	Number of Elements	Inner Diameter Ø mm/ inch	Volume (mL)	Units/ Box	Stepped Tip (T)	Straight Tip (D)	Hanger Bracket	Extension tube	Ribbon adapter	
							✓	✓	✓	✓	✓	
MGQ 	300469	MGQ 08-18T	18	8.7/0.343	6.7	1200	✓				✓	
	300454	MGQ 08-20D	20	8.7/0.343	7.57	1000		✓		✓		
	300453	MGQ 08-20T	20	8.7/0.343	7.34	1000	✓					
	300462	MGQ 08-24D	24	8.7/0.343	8.61	800		✓		✓		
	300461	MGQ 08-24T	24	8.7/0.343	8.76	800	✓				✓	
	154897	MGQ 10-16D	16	10.7/0.421	12.69	800		✓		✓		
	300493	MGQ 10-19D	19	10.7/0.421	12.15	800		✓		✓		
	300497	MGQ 10-24D	24	10.7/0.421	14.49	650		✓		✓		
	158039	MGQ 10-10A-02	10	10/0.394	11.2	500				✓		
	119514	MGQ 10-14A	14	10.7/0.421	11.9	1188				✓		
	154733	MGQ 10-14A-30	14	10.7/0.421	16	220		✓				
	154893	MGQ 10-16A	16	10.7/0.421	15.0	800				✓		
	162526	MGQ 10-16A-30	16	10.7/0.421	15.0	220			✓	✓		
	154913	MGQ 10-19A	19	10.7/0.421	14.0	400				✓		
	154898	MGQ 10-19A-95	19	10.7/0.421	12.5	400				✓		
	154734	MGQ 10-19A-30	19	10.7/0.421	14.0	220			✓	✓		
	KMGQ 	154926	MGQ 14-20	20	14/0.551	34.7	700				✓	
		154930	KMGQ 14-20E	20	14/0.551	61	400				✓	
		154931	KMGQ 14-38E	18	13/0.512	53	400				✓	
				20	14/0.551							

Matching dispensers

	ID	Article	Additional plunger	Volume mL			Ratio 10:1	Force (kN)
				150	310	380		
DM1, DP1, DB1 dispenser manual 	151727	DM1 310-50-400	✓	✓		✓	5.0	
	159342	DP1 63004-300HP	✓	✓		✓	2.5	
	152478	DB1 00-25-113	✓	✓		✓	2.5	
DM2 dispenser manual 	151769	DM2 300-50-100		✓	✓	✓	5.0	
	151763	DM2 380-50-100			✓	✓	5.0	
DB2 dispenser battery 	158093	DB2 380-27-150			✓	✓	2.75	